

Data Sheet



Article number: 2310431151S

Description: E+G Levelling elements
LX.30-SW17-SST-M6X24-S

Measures

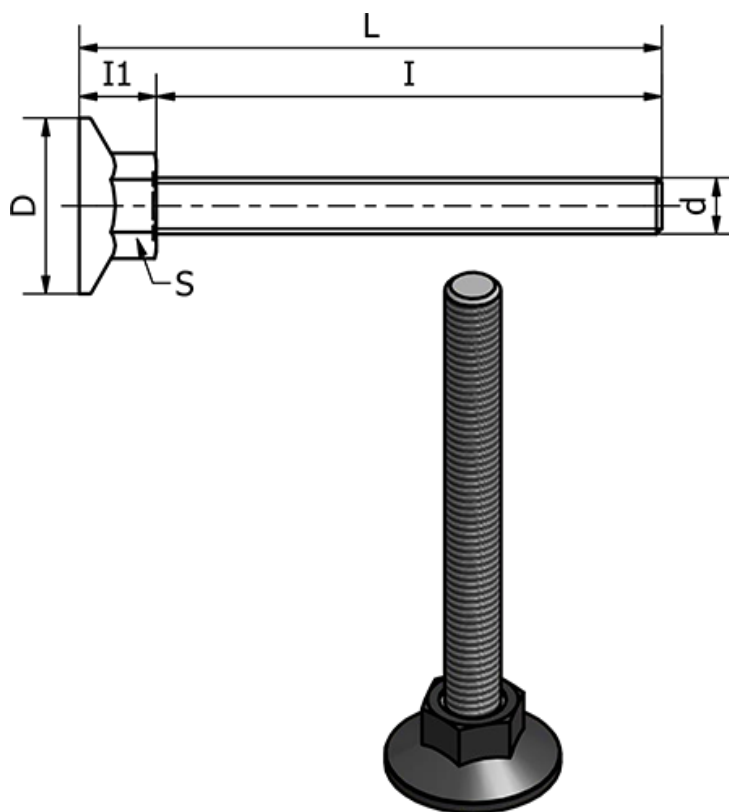

d = M6

D = 30

I = 24

I1 = 12

L = 36

S = 17

Static load in (N) = 1500

Type = AISI 304 Rustfast

Weight (g) = -